

INTHER  
^



PT

BURLETES



HERRAJES  
PARA PROYECTOS TÉCNICOS

# 04

## BURLETES

4.1. 1700 XNS



Págs

98

4.2. 1700



Págs

99

4.3. 1703 ACU



Págs

100

4.4. 400 MINI



Págs

101

4.5. 1450 COMAX



Págs

102

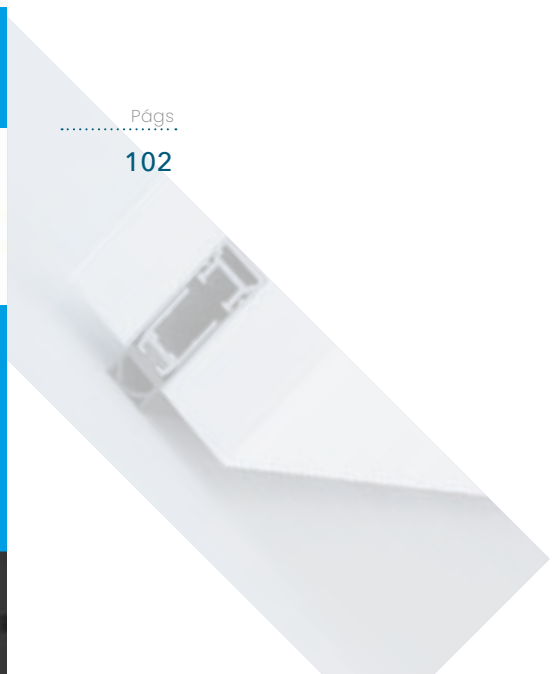



## Burletes



- Los burletes INHER garantizan una completa estanqueidad de cierre entre el pavimento y la puerta.
- El uso de los burletes aporta protección al viento, agua, luz, insectos, ruido, fuego y humo.
- Los burletes están homologados y clasificados según el grado de isofonía que aportan (hasta 54 dB).

PT

BURLETES



^ **Burletes**

1700  
XNS



Isófono  
54 dB



200.000  
ciclos



EN 1634-1



Cortable  
a 10 cm.

1700



Isófono  
35 dB



200.000  
ciclos



EN 1634-1



Cortable  
a 10 cm.

1703 ACU



Isófono  
50 dB



200.000  
ciclos



EN 1634-1



Cortable  
a 10 cm.

400  
Mini



Isófono  
38 dB



200.000  
ciclos



EN 1634-1



Cortable  
a 20 cm.

1450  
COMAX



200.000  
ciclos



Cortable  
a 20 cm.



Isófono  
54 dB



200.000  
ciclos



EN 1634-1

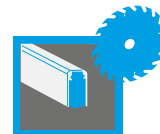

Cortable  
a 10 cm.



### Características técnicas

- Burlete isófono 54 dB.
- Mecanismo de doble ajuste
- Perfil móvil deslizante
- Pulsador lateral hexagonal de latón
- Segundo tornillo de ajuste de latón
- Muelles de acero Inox.
- Junta de silicona autoextinguible
- Mecanismo patentado
- Cortable 10 cm.

- Opcional juego de escuadras



Código	Descripción	Medida	Acabado	Set
13277	Burlete 1700 XNS - RF 825	825-725 mm.	PL	10
13278	Burlete 1700 XNS - RF 925	925-825 mm.	PL	10
13279	Burlete 1700 XNS - RF 1025	1025-925 mm.	PL	10
13280	Burlete 1700 XNS - RF 1125	1125-1025 mm.	PL	10
13281	Burlete 1700 XNS - RF 1225	1225-1125 mm.	PL	10
14872	Juego de escuadras 1700 XNS	-	INOX 304	1/20

### Plano

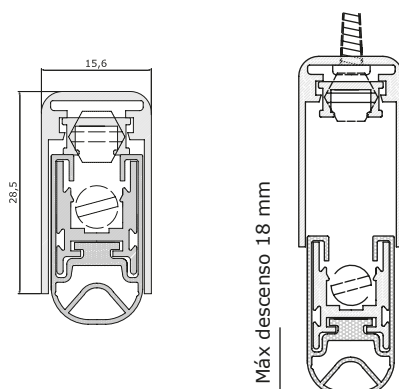

### Sección

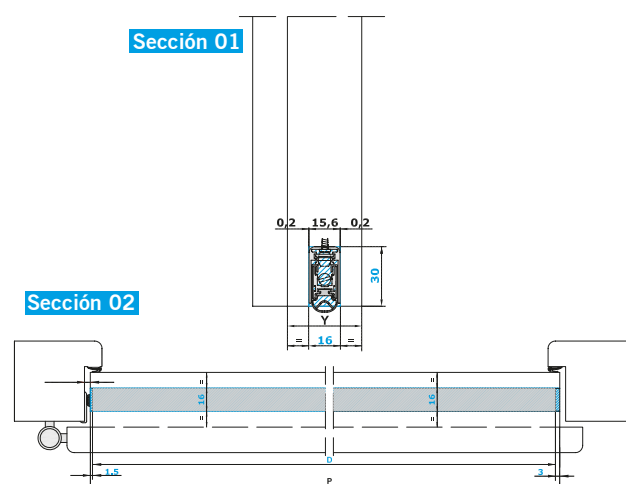

Descarga las fichas técnicas en [www.inther.es](http://www.inther.es)



Isófono  
35 dB



200.000  
ciclos



EN 1634-1

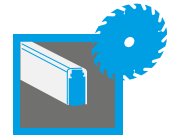

Cortable  
a 10 cm.



### Características técnicas

- Burlete isófono 35 dB.
- Mecanismo de doble ajuste
- Perfil móvil deslizante
- Pulsador lateral hexagonal de latón
- Segundo tornillo de ajuste de latón
- Muelles de acero Inox.
- Junta de silicona autoextinguible
- Mecanismo patentado
- Cortable 10 cm.

- Opcional juego de escuadras



Código	Descripción	Medida	Acabado	Set
41332	Burlete 1700 - RF 525	525-425 mm.	PL	10
14411	Burlete 1700 - RF 625	625-525 mm.	PL	10
01250	Burlete 1700 - RF 725	725-625 mm.	PL	10
65699	Burlete 1700 - RF 825	825-725 mm.	PL	10
01252	Burlete 1700 - RF 925	925-825 mm.	PL	10
01254	Burlete 1700 - RF 1025	1025-925 mm.	PL	10
12549	Burlete 1700 - RF 1125	1125-1025 mm.	PL	10
12550	Burlete 1700 - RF 1225	1225-1125 mm.	PL	10
12551	Burlete 1700 - RF 1325	1325-1225 mm.	PL	10
14872	Juego escuadras 1700	-	INOX 304	1/20

### Plano

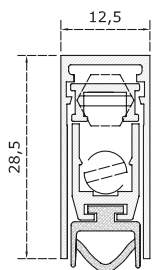

Máx descenso 18 mm

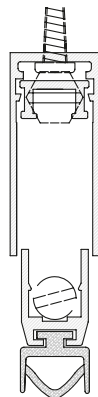

### Sección

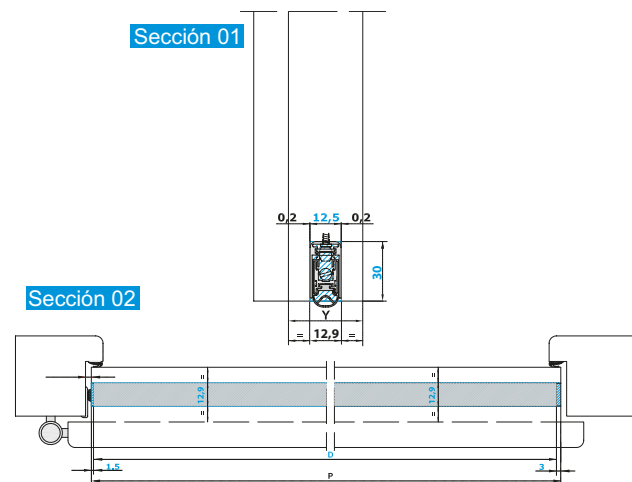

Descarga las fichas técnicas en [www.inther.es](http://www.inther.es)



Isófono  
50 dB



200.000  
ciclos



EN 1634-1



Cortable  
a 10 cm.



### Características técnicas

- Burlete isófono 50 dB.
- Mecanismo basculante.
- Perfil móvil deslizante
- Pulsador lateral hexagonal de latón.
- Muelles de acero Inox.
- Junta de silicona RF autoextinguible.
- Mecanismo patentado.
- Cortable 10 cm.

- Opcional juego de escuadras



Código	Descripción	Medida	Acabado	Set
15381	Burlete 1703 ACU - 725	725-625 mm.	PL	10
15382	Burlete 1703 ACU - 825	825-725 mm.	PL	10
15383	Burlete 1703 ACU - 925	925-825 mm.	PL	10
15384	Burlete 1703 ACU - 1025	1025-925 mm.	PL	10
15385	Burlete 1703 ACU - 1125	1125-1025 mm	PL	10
14872	Juego de escuadras 1703 ACU	-	INOX 304	1/20

### Plano

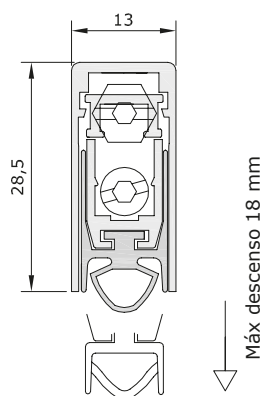

### Sección

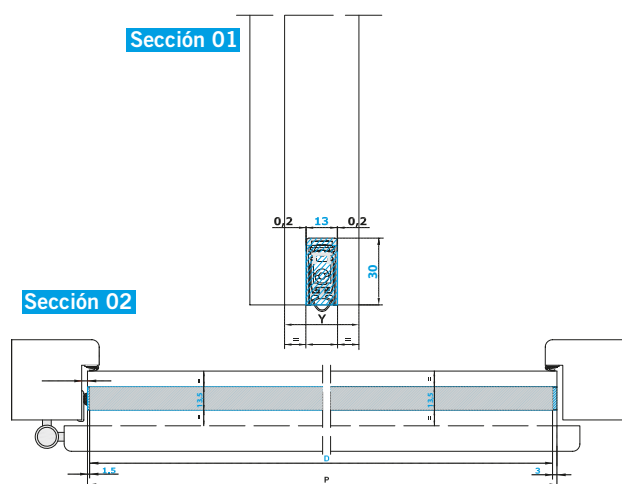

Descarga las fichas técnicas en [www.inther.es](http://www.inther.es)



Isófono  
38 dB



200.000  
ciclos



EN 1634-1

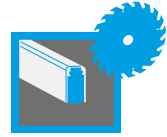

Cortable  
a 20 cm.



### Características técnicas

- Burlete isófono 38 dB.
- Mecanismo basculante
- Perfil móvil deslizante
- Pulsador lateral hexagonal de latón
- Muelles de acero Inox.
- Junta de silicona RF autoextinguible
- Mecanismo patentado
- Cortable 20 cm.

- Opcional juego de escuadras



Código	Descripción	Medida	Acabado	Set
10893	Burlete 400 MINI - 825	825-625 mm.	PL	50
12334	Burlete 400 MINI - 925	925-725 mm.	PL	50
10901	Burlete 400 MINI - 1125	1125-925 mm.	PL	50
14873	Juego de escuadras 400 MINI	-	INOX 304	1/20

### Plano

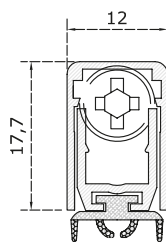

Máx descenso 11 mm

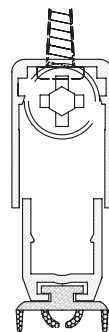

### Sección

Sección 01

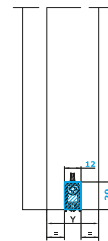

Sección 02

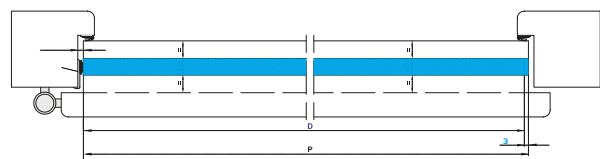

Descarga las fichas técnicas en [www.inther.es](http://www.inther.es)



200.000  
ciclos



Cortable  
a 20 cm.

### Características técnicas

- Mecanismo basculante
- Protectores plásticos
- Activación del mecanismo en el lado de la bisagra o en el lado batiente
- Cortable 20 cm.

Código	Descripción	Medida	Acabado	Set
56208	Burlete 1450 COMAX - 925	925-725 mm.	PL	10
56209	Burlete 1450 COMAX - 925	925-725 mm.	BL	10
06405	Burlete 1450 COMAX - 925	925-725 mm.	BR	10

### Plano

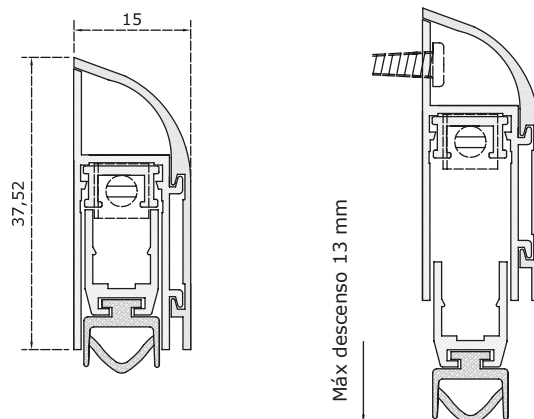

Descarga las fichas técnicas en [www.inther.es](http://www.inther.es)

### Burlete Embutido

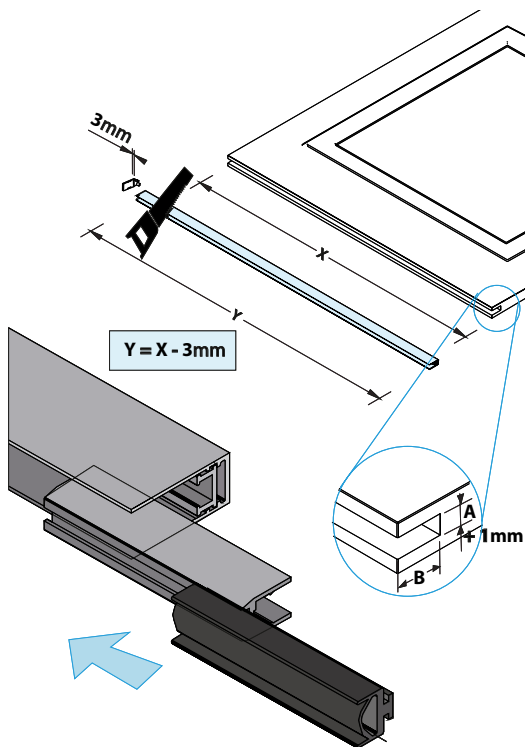

1700 XNS

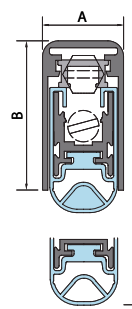

1700

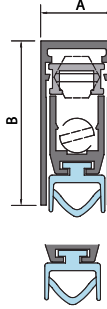

1703 ACU

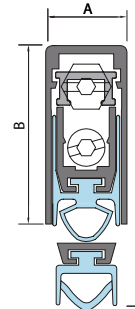

400 MINI

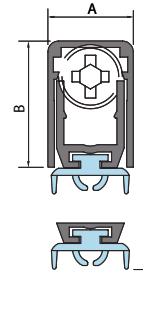

### Burlete Sobrepuesto

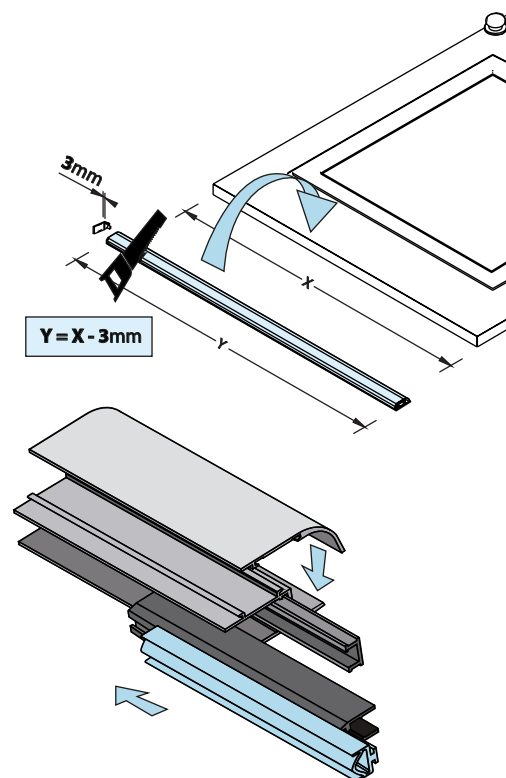
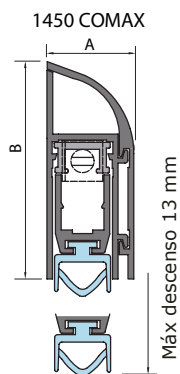

Comfort in your life



[www.inther.es](http://www.inther.es)

