

Cierrapuertas

CTG 63

INTHER



EN 1634-1



PIÑÓN

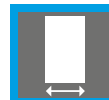

≤950



60 kg

EN
3

EN
1154



Características técnicas

- Fuerza fija 3
- Ancho hoja ≤ 950
- Mecanismo piñón-cremallera
- Regulación del golpe final 15°-0°
- Regulación velocidad de cierre 180°-15°
- Freno a la apertura 75° >
- Marcado CE
- Apto para puerta RF

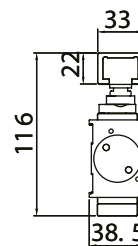
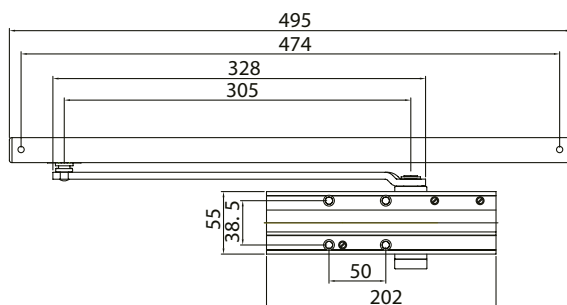

Colores disponibles



*Oro



Plata



Negro

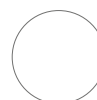

Blanco

Características

Código	Descripción	Acabado	Retención	Set
14614	CTG63 EN 3	BL	-	1/6
60124	CTG63 EN 3	PL	-	1/6
14613	CTG63 EN 3	NE	-	1/6
14829	CTG63 EN 3	ORO	-	1/6
14806	Retención CTG63	-	✓	1/100
14808	Freno apertura CTG63	-	✓	1/100

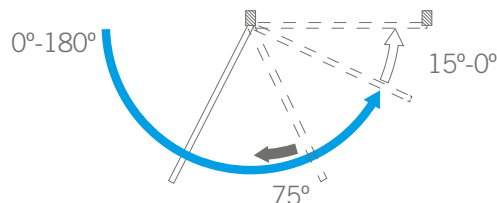

- Velocidad de golpe final
- Velocidad de cierre
- Freno de apertura

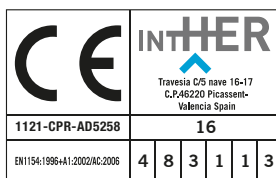

EN 1634-1

Descarga la declaración de prestaciones en www.inther.es

Montaje Estándar

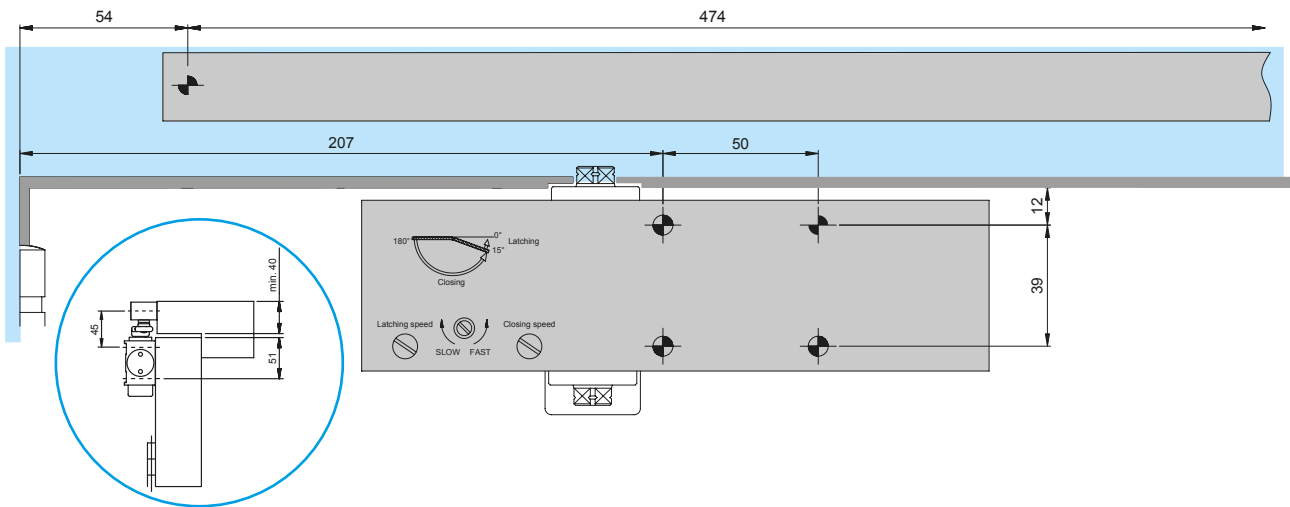

Montaje Inverso

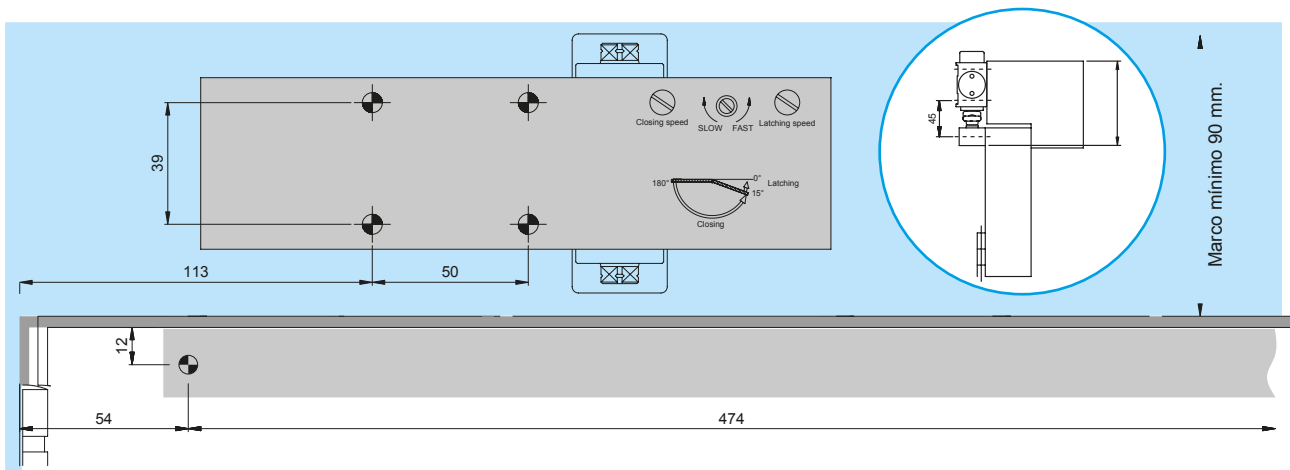

Montaje Inverso lado contrario

